

Technical Specification Sheet

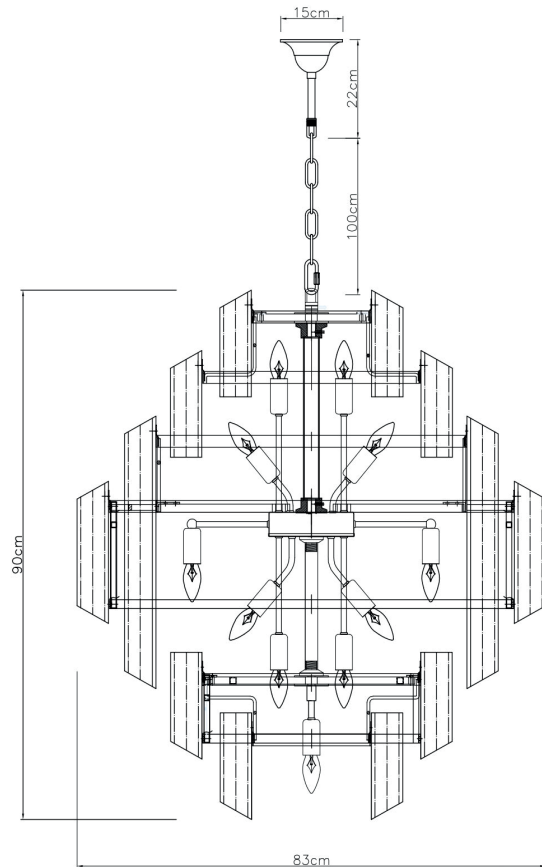

Grande Palermo Chandelier

A 70's inspired chandelier with a Polished Nickel or Satin Brass frame and glass tubes hung to create 7 tiers



Technical Specification Sheet

Dimensions
excluding rose & chain (cm)

W	D	H
83	83	90

Minimum drop
(excluding glass & frame)

21cm

Maximum drop
(excluding glass & frame)

122cm

Weight

76.6kg



Product code

PWL34511





Materials

Plated iron / glass

Metal finish

-  Satin Brass
-  Polished Nickel

Glass colour

-  Amber
-  Clear
-  Pink
-  Smoked Mirror

Suitable for outside/wet

No

Suitable for dimming

Yes

Max wattage

40W (equivalent to 5W LED)

 Bulb requirements

19 bulbs, E14 (not included)

 Chain length

100cm

Chain colour

Satin Brass / Polished Nickel

Cable length

120cm

Cable colour

Gold / Silver

Inline switch

n/a

 Ceiling rose Ø

15cm

Ceiling rose height

16 - 22cm

Ceiling rose colour

Satin Brass / Polished Nickel

Ceiling bracket Ø

11cm

Packaging dims Box 1

W77 x D77 x H88cm

Packaging dims Box 2

W123 x D74 x H40cm

Packaging weight

Box 1: 15.8kg Box 2: 70.4kg

Assembly required

Partial



 View Product